

Silencers, series S11

1827000002

General series information
AVENTICS Series S11 Silencers

- AVENTICS Series S11 Silencers offers a broad range of silencers even in Metal or plastic to reduce the noise when Pneumatic products come to exhaust.

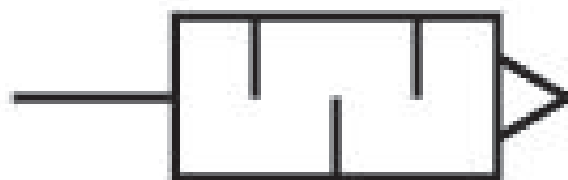

Technical data

Industry	Industrial
Medium	Compressed air
Working pressure min.	0 bar
Working pressure max	10 bar
Min. ambient temperature	-25 °C
Max. ambient temperature	80 °C
Compressed air connection	G 3/8
Compressed air connection type	External thread
Sound pressure level	84 dB
Nominal flow Qn	6554 l/min
Delivery unit	5 piece
Weight	0.05 kg

Material

Silencer material

Sintered bronze

Material thread

Brass

Part No.

1827000002

Dimensions in mm

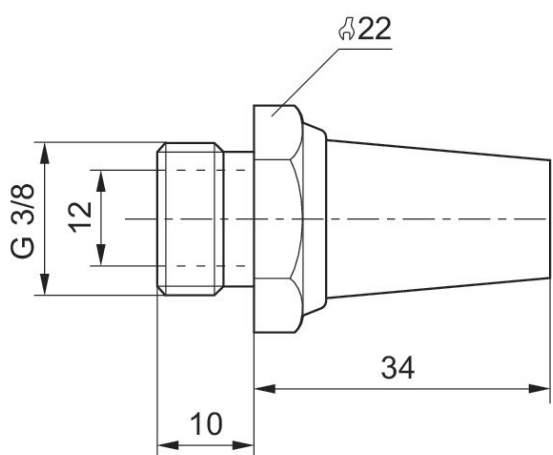

Flow diagram

1827000002

